

## Coûts énergétiques

Méthode	kWh/kg MS	kWh/kg HE	Temps d'extraction
Entrainement à la vapeur	1 à 25	50 à 1250	1 à 24 h
CO <sub>2</sub> Supercritique	2	100	1 à 8 h
Autovaporisation DIC	0,5	15	1 à 4 min

## Micro-mechanical effect of DIC on the structural changes

Scanning by Electronic Microscopy SEM

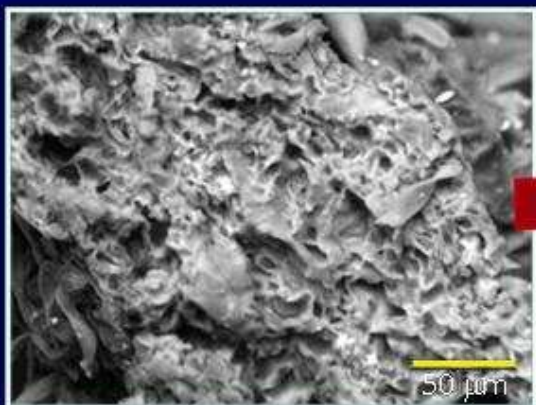

Raw material

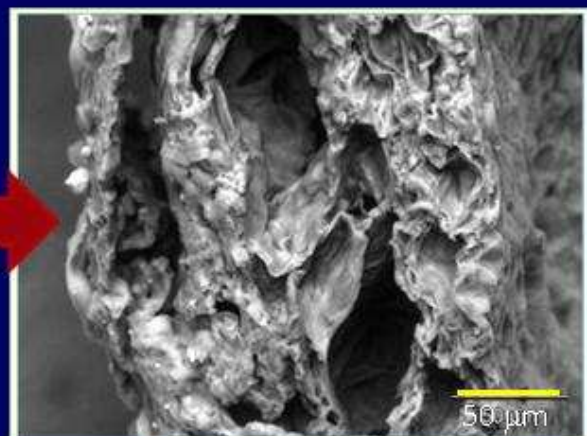

DIC alveolated material

## Extraction des volatiles / huiles essentielles

### Avantages de la DIC

- **Qualité**
  - Absence de solvant dans les extraits.
  - Absence de dégradation thermique.
- **Impact Environnemental**
  - Valorisation de la matière résiduelle.
  - Réduction de la consommation d'eau résiduelle.
- **Coût**
  - Réduction de la consommation d'énergie et augmentation notable de la valeur économique de l'extrait.



## Extraction des non-volatiles / principes actifs

### Avantages de la DIC

L'expansion par DIC du produit Induit :

- Meilleur accès du solvant aux molécules à extraire
- Meilleurs rendements en éléments actifs
- Un temps d'extraction plus réduit,
- Une quantité de solvant et d'énergie plus faible





## Cinétique d'extraction par solvant EAU:ETHANOL de molécules non volatiles (Principes actifs)

### Cinétique d'extraction des AMT

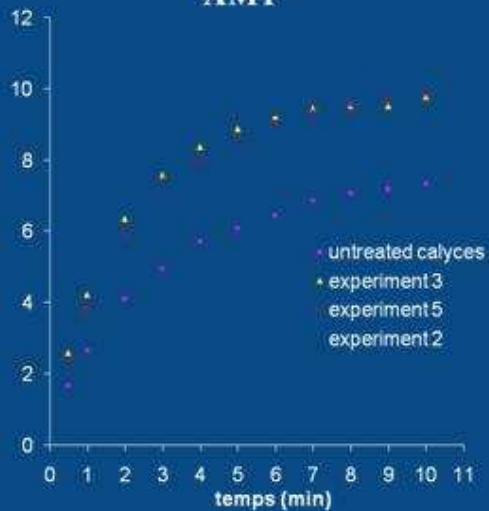

### Cinétique d'extraction de Dp-3sam

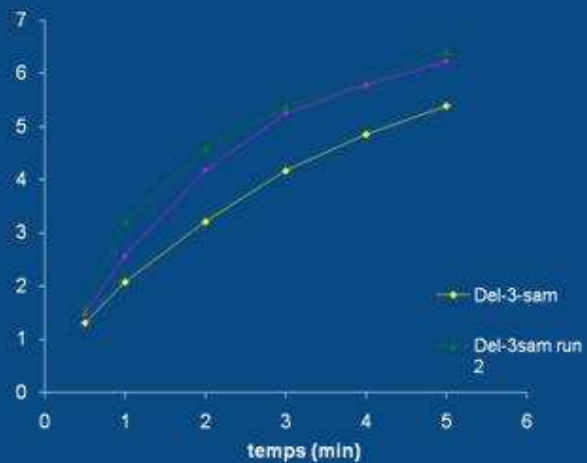

13/01/2011

36

## Cinétique d'extraction par solvant de molécules non-volatiles

### Cinétique d'extraction du cicérolol

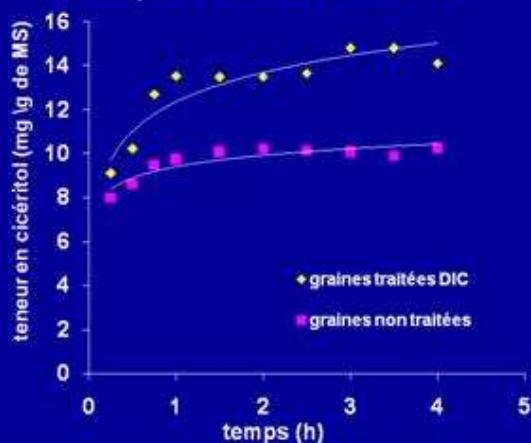

### cinétique d'extraction du stachyose

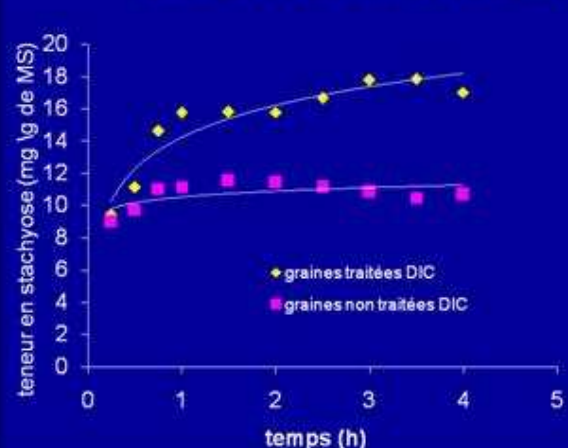

Conditions DIC: 0,6 MPa ; 22 (g/100g MS) ; 135 s

13/01/2011

37

# Extraction et séparation par DIC

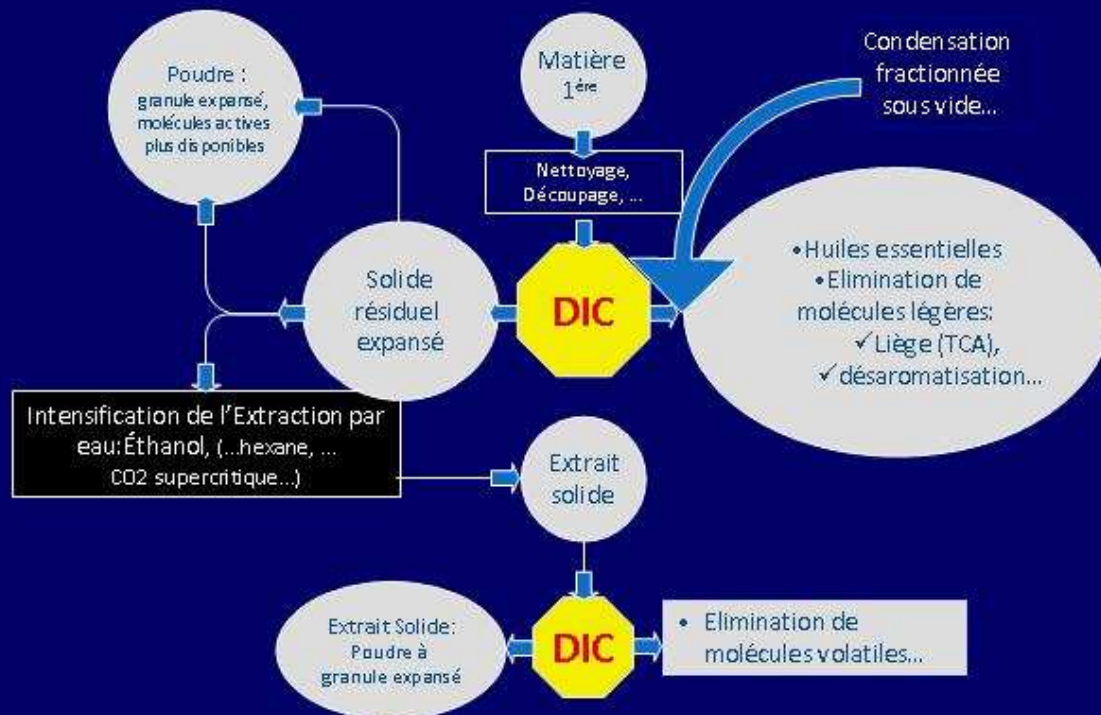

13/01/2011

Prof. Karim ALLAF,  
Univ. La Rochelle

## Extraction par solvant des molécules actives : Produit brut et produit traité par DIC

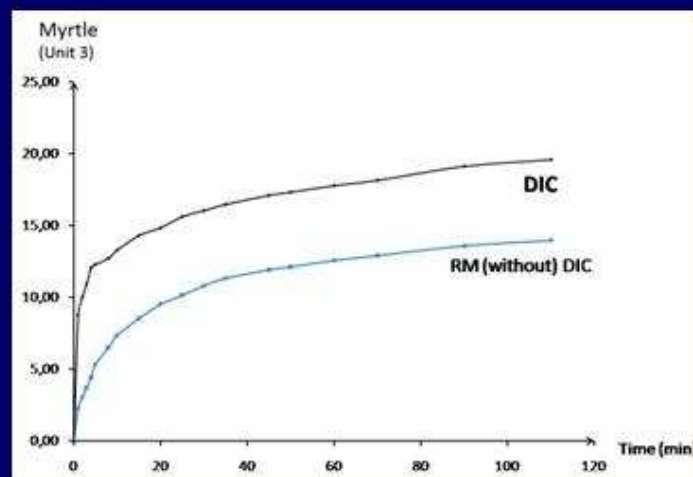

Flavonoïdes  
de la myrte algérienne

13/01/2011

39

**Creation of innovative Companies:**

ABCAR-DIC Process (France);

ABCAR-Mexico

FLORINNOV (France)

Legni & Segni (Italy)

ABCAR-ASIA (Malaysia)

**Various Industrial realizations and Productions:**

•Universal Foods	(California - USA):	Vegetables	(1993)
•Coralma	(France):	Tobacco	(1996-2001)
•BONTOUT	(France):	Sterilization Mushrooms	(2001)
•ATEX	(France):	Sterilization Mushrooms	(2001)
•Unilever	(Holland):	Tea	(2002)
•Protekum	(Germany):	Flavonoids	(2002)
•AZTI	(Spain):	Fish oil	(2004)
•Contento trade	(Italy)	Mineral products	
•SETALG	(France):	Sterilization/Drying seaweeds	(2005)
•TOURNAY	(France):	Drying/Extraction flavonoids	(2006)
•UBAYA	(Indonesia):	Extraction & Medicines	(2007)
•ABCAR-MEXICO	(Mexico):	Fruits and vegetables	(2009)
•ABCAR-ASIA	(Malaysia)	Fruits and vegetables	(2009) ABCAR-
ABCAR-DIC USA	(United States)	Fruits and vegetables	(2010)

**DIC = 22 years of research and 26 Ph-D works ...**



**DIC reactors**

**Laboratory scale DIC Machines:**

DIC-LAB-1

**Industrial DIC equipment:**

1. DIC-TUBular-15
2. DIC-LINear-1  
and Manual – DIC LINear - 2
3. DIC-SELF-LUBricating
4. DIC-DIAGonal
5. STATIC-DIC
6. DYNAMIC-DIC



# DIC TUBular – 15

## Self-blocking reactor

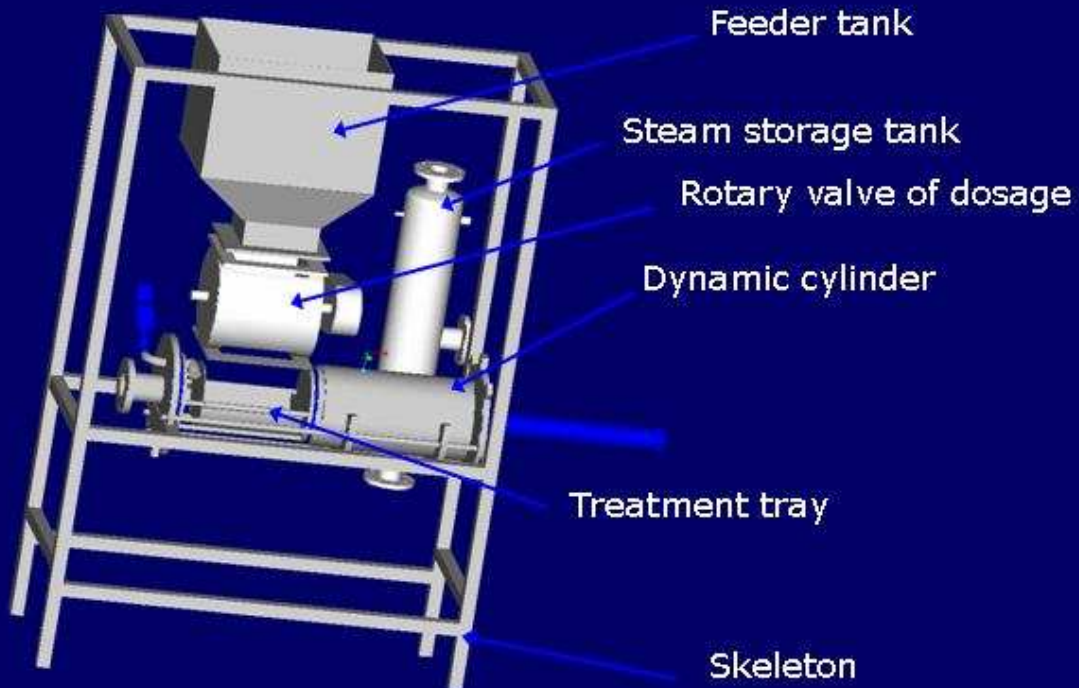

13/01/2011

42



# Alicante (Espagne)



## 2. DIC-LINear-1

1. On trays machine (0,6m<sup>2</sup>),
2. Ideal for treatment of in pieces fruits and vegetables
3. Ideal for drying, sterilization, etc.
4. Easy to insert it in a classic treatment line.



## 2. DIC-LINear-1



## 2. Manual-DIC-LINear-2

1. On trays machine (2.5 m<sup>2</sup>),
2. Ideal for treatment of in pieces fruits and vegetables
3. Ideal for drying, sterilization, etc.
4. Easy to insert it in a classic treatment line.
5. Comfortable maintenance



## 2. Manual-DIC-LINear-2

### Self – blocking system

Manual functioning

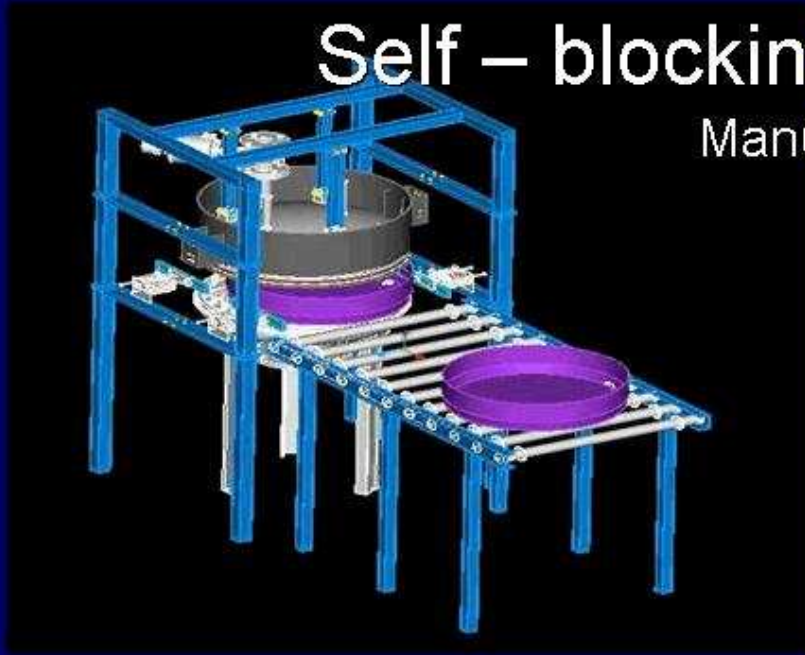

13/01/2011

Prof. Karim ALLAF,  
Univ. La Rochelle 49/100



NUTRIMEZA S.A. de C.V.

*Mexique - Amérique*

## 4. DIC-DIAGonal

- **50 liters industrial machine;**
- **Ideal for treatment of specific herbs (tobacco, tea, etc.).**

## 4. DIC-DIAGonal

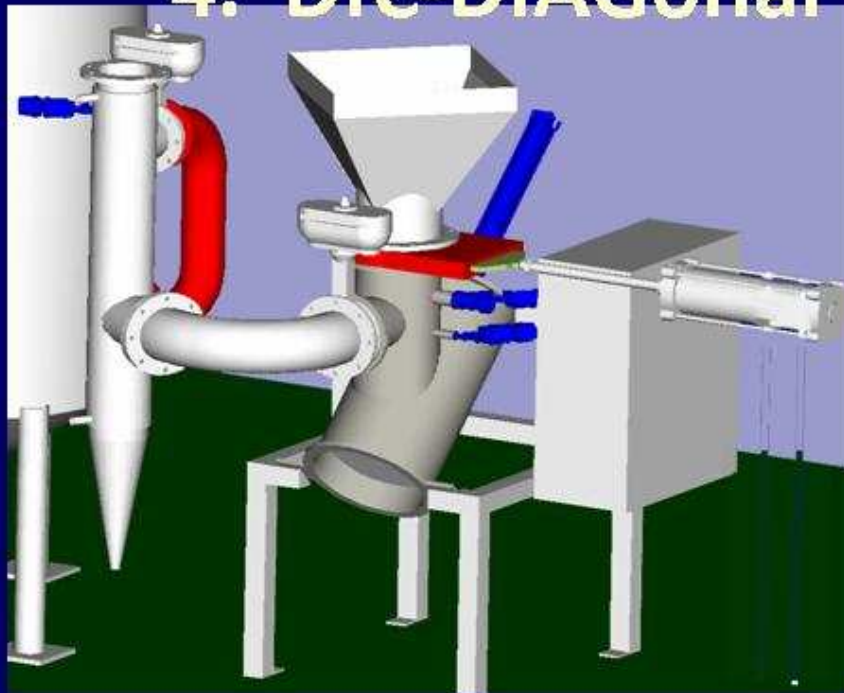



## 4. DIC-DIAGonal



Prof. Karim ALLAF,  
Univ. La Rochelle /100

## STATIC-DIC: Universal Foods USA/ Sensient France

- Carousal, flat-bed, NSI System,
- 2 versions: 0,5 m<sup>2</sup> - 2m<sup>2</sup>,
- Adapted to be installed in an “on line hot-air classic drying”.



# STATIC-DIC: Universal Foods USA/ Sensient France

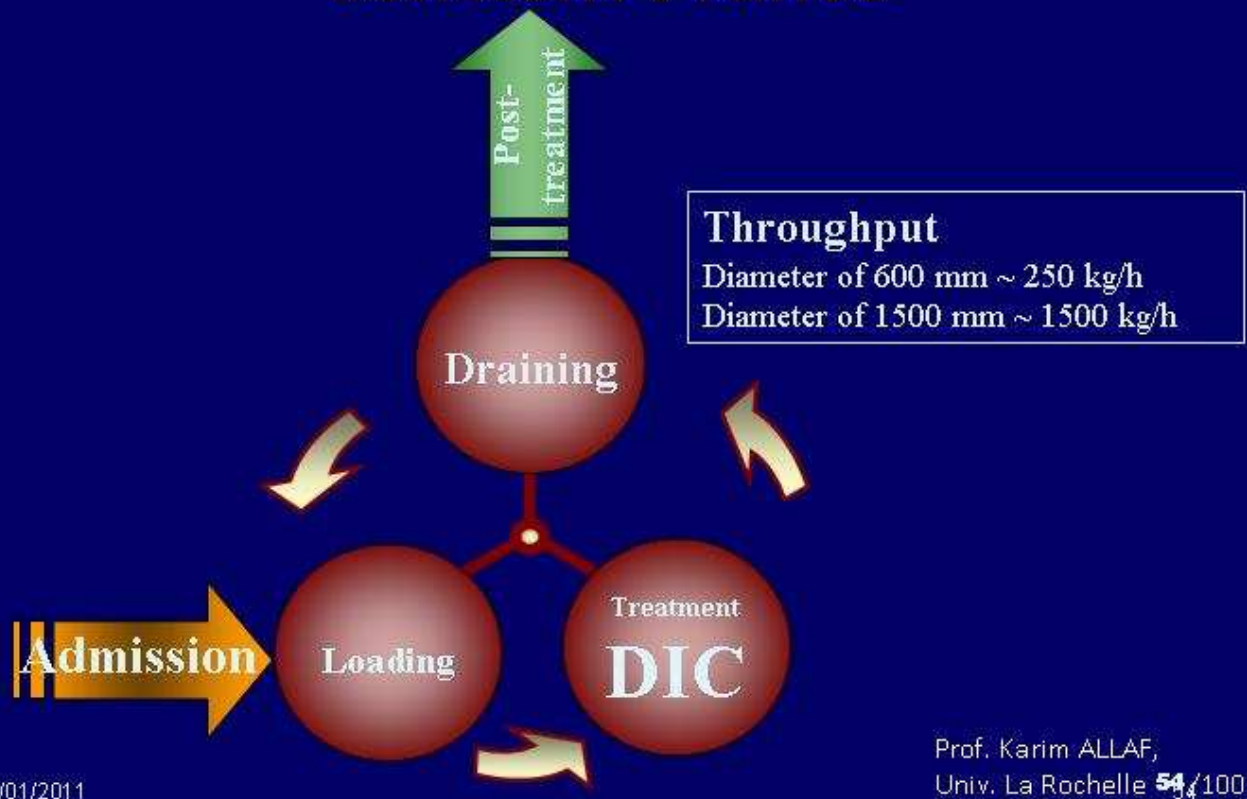

# STATIC-DIC: Universal Foods USA/ Sensient France

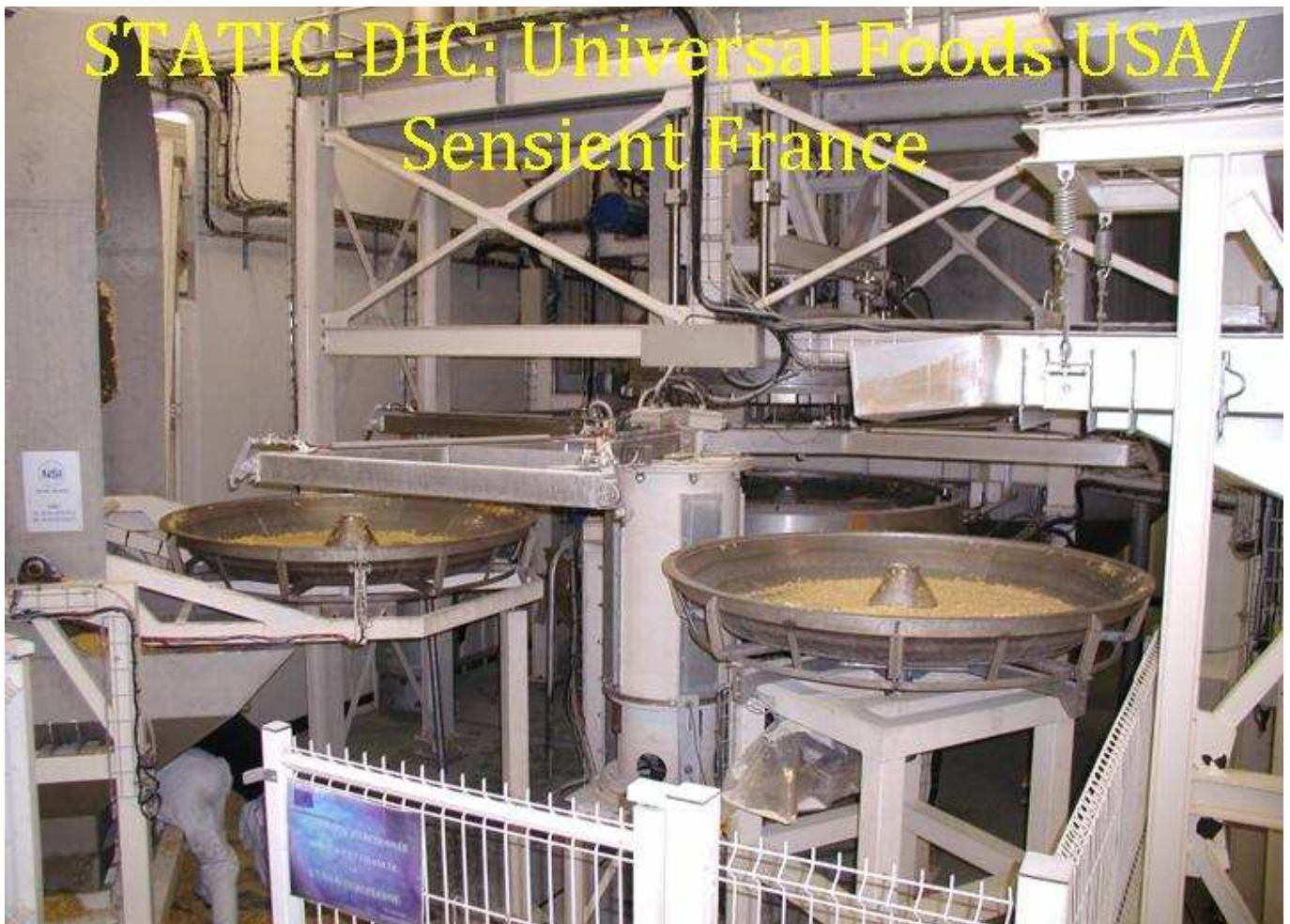



## 6. DYNAMIC-DIC

- Vertical Industrial DIC System
- Gravitational loading;
- Industrial machine adapted to non fragile products.

13/01/2011

56

## 6. DYNAMIC-DIC Reactor

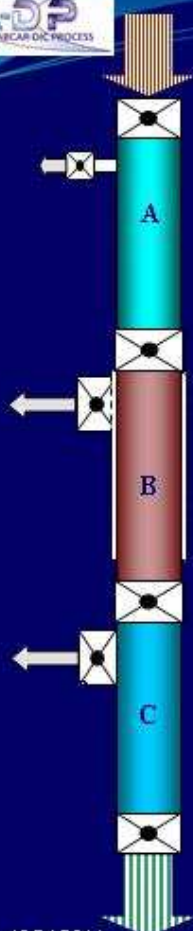

13/01/2011

57



ABCAR-DIC PROCESS La Rochelle  
*France - Europe*

13/01/2011

Transferring of DIC Technology towards ASIA

58

Université de La Rochelle

Laboratory **T**ransfer **P**henomena and **I**ntantaneity in **A**gro-industry and **B**uilding

**LEPTIAB**

**Pr. Karim Allaf,**

CO-ORDINATOR OF AGRO-INDUSTRIAL TECHNOLOGIES

Pole Sciences & Technologie

Avenue Michel Crépeau

17042 La Rochelle Cedex 01 (France)

Phone +33 05.46.45.87.66

Fax +33 05.46.45.86.16

Email [kallaf@univ-lr.fr](mailto:kallaf@univ-lr.fr)

13/01/2011

59



# ABCAR DIC Process SAS –

RCS N° SIREN : 434 715 603 000 16 Code d'activité : 742 C



Equipement & Engineering for Industry  
*Innovating Industrial Technology*

**Société de recherche agréée par le ministère de la  
Recherche Scientifique (France)**



**[www.abcar-dic.com](http://www.abcar-dic.com)**

**[Laurent.lefevre@abcar-dic.com](mailto:Laurent.lefevre@abcar-dic.com)**

📍 40, rue Chef de Baie 17000 La Rochelle (France)

☎ 33 546 07 47 00 📞 33 64 5 64 1757 📠 33 546 30 60 78

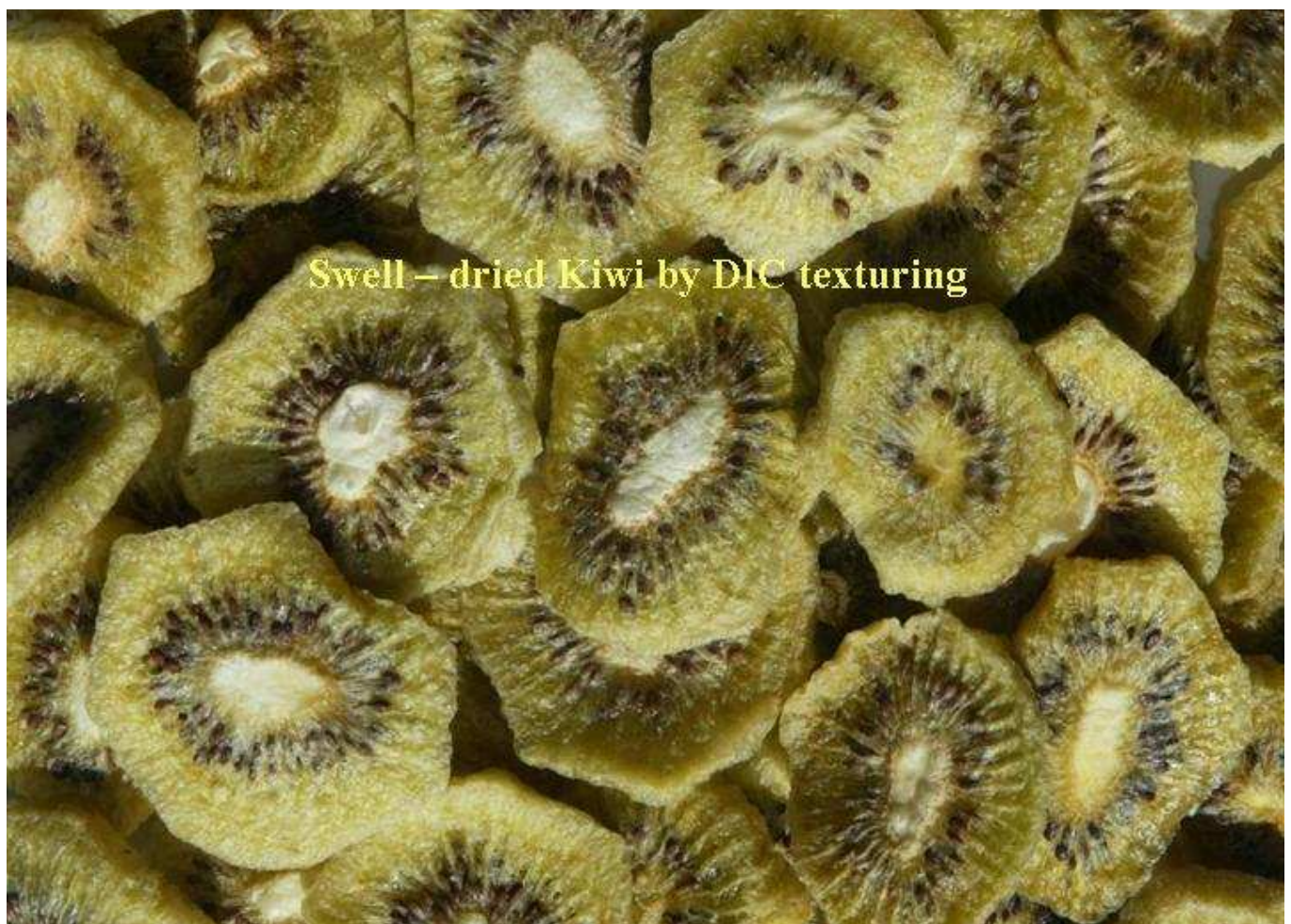

**Swell – dried Kiwi by DIC texturing**